

**KIRKLAND**  
*Signature*™

By **Whirlpool**  
CORPORATION

---

# UNDERCOUNTER DISHWASHER

Use & Care Guide

---

Table of Contents ..... 2

---

**Models SUD4000  
8051559**

---

# TABLE OF CONTENTS

<b>DISHWASHER SAFETY</b> .....	3
Before Using Your Dishwasher .....	4
<b>PARTS AND FEATURES</b> .....	5
<b>START-UP GUIDE</b> .....	6
Using Your New Dishwasher .....	6
Stopping Your Dishwasher.....	6
<b>LOADING YOUR DISHWASHER</b> .....	7
Loading Suggestions .....	7
Loading the Top Rack .....	7
Loading the Bottom Rack .....	8
Loading the Silverware Basket .....	8
<b>USING YOUR DISHWASHER</b> .....	9
Detergent Dispenser .....	9
How Much Detergent to Use.....	9
Rinse Aid Dispenser.....	10
Dishwasher Efficiency Tips .....	10
Cycle Selection Chart .....	11
Canceling a Cycle .....	11
Changing a Cycle or Setting.....	11
Adding Items During a Cycle.....	11
Option Selections.....	12
Drying System .....	12
Overfill Protection Float .....	12
<b>WASHING SPECIAL ITEMS</b> .....	13
<b>CARING FOR YOUR DISHWASHER</b> .....	14
Cleaning Your Dishwasher .....	14
Cleaning the Filter Screen .....	14
Drain Air Gap .....	14
Storing Your Dishwasher .....	15
<b>TROUBLESHOOTING</b> .....	16
<b>ASSISTANCE OR SERVICE</b> .....	18
In the U.S.A.....	18
In Canada.....	18
<b>WARRANTY</b> .....	20

# DISHWASHER SAFETY

## Your safety and the safety of others is very important.

We have provided many important safety messages in this manual and on your appliance. Always read and obey all safety messages.



This is the safety alert symbol.

This symbol alerts you to hazards that can kill or hurt you and others.

All safety messages will be preceded by the safety alert symbol and the word "DANGER" or "WARNING." These words mean:

 **DANGER**

You will be killed or seriously injured if you don't follow instructions.

 **WARNING**

You can be killed or seriously injured if you don't follow instructions.

All safety messages will identify the hazard, tell you how to reduce the chance of injury, and tell you what can happen if the instructions are not followed.

## IMPORTANT SAFETY INSTRUCTIONS

**WARNING:** When using the dishwasher, follow basic precautions, including the following:

- Read all instructions before using the dishwasher.
- Use the dishwasher only for its intended function.
- Use only detergents or rinse agents recommended for use in a dishwasher, and keep them out of the reach of children.
- When loading items to be washed:
  - 1) Locate sharp items so that they are not likely to damage the door seal; and
  - 2) Load sharp knives with the handles up to reduce the risk of cut-type injuries.
- Do not wash plastic items unless they are marked "dishwasher safe" or the equivalent. For plastic items not so marked, check the manufacturer's recommendations.
- Do not touch the heating element during or immediately after use.
- Do not operate the dishwasher unless all enclosure panels are properly in place.
- Do not tamper with controls.
- Do not abuse, sit on, or stand on the door or dish racks of the dishwasher.
- To reduce the risk of injury, do not allow children to play in or on the dishwasher.
- Under certain conditions, hydrogen gas may be produced in a hot water system that has not been used for two weeks or more. **HYDROGEN GAS IS EXPLOSIVE.** If the hot water system has not been used for such a period, before using the dishwasher turn on all hot water faucets and let the water flow from each for several minutes. This will release any accumulated hydrogen gas. As the gas is flammable, do not smoke or use an open flame during this time.
- Remove the door to the washing compartment when removing an old dishwasher from service or discarding it.

**SAVE THESE INSTRUCTIONS**

## Before Using Your Dishwasher

### **! WARNING**

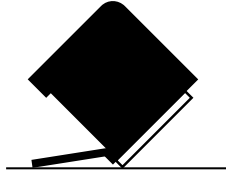

#### **Tip Over Hazard**

**Do not use dishwasher until completely installed.**

**Do not push down on open door.**

**Doing so can result in serious injury or cuts.**

### **! WARNING**



#### **Electrical Shock Hazard**

**Electrically ground dishwasher.**

**Connect ground wire to green ground connector in terminal box.**

**Do not use an extension cord.**

**Failure to follow these instructions can result in death, fire, or electrical shock.**

## **GROUNDING INSTRUCTIONS**

- **For a grounded, cord-connected dishwasher:**  
The dishwasher must be grounded. In the event of a malfunction or breakdown, grounding will reduce the risk of electric shock by providing a path of least resistance for electric current. The dishwasher is equipped with a cord having an equipment-grounding conductor and a grounding plug. The plug must be plugged into an appropriate outlet that is installed and grounded in accordance with all local codes and ordinances.

**WARNING:** Improper connection of the equipment-grounding conductor can result in a risk of electric shock. Check with a qualified electrician or service representative if you are in doubt whether the dishwasher is properly grounded. Do not modify the plug provided with the dishwasher; if it will not fit the outlet, have a proper outlet installed by a qualified electrician.

- **For a permanently connected dishwasher:**  
The dishwasher must be connected to a grounded metal, permanent wiring system, or an equipment-grounding conductor must be run with the circuit conductors and connected to the equipment-grounding terminal or lead on the dishwasher.

## **SAVE THESE INSTRUCTIONS**

- Install where dishwasher is protected from the elements. Protect against freezing to avoid possible rupture of fill valve. Such ruptures are not covered by the warranty. See "Storing Your Dishwasher" in the "Caring for Your Dishwasher" section for winter storage information.
- Install and level dishwasher on a floor that will hold the weight, and in an area suitable for its size and use.
- Remove all shipping plugs from hoses and connectors (such as the cap on the drain outlet) before installing. See Installation Instructions for complete information.

# PARTS AND FEATURES

**NOTE:** The features on your dishwasher may vary from the drawing shown.

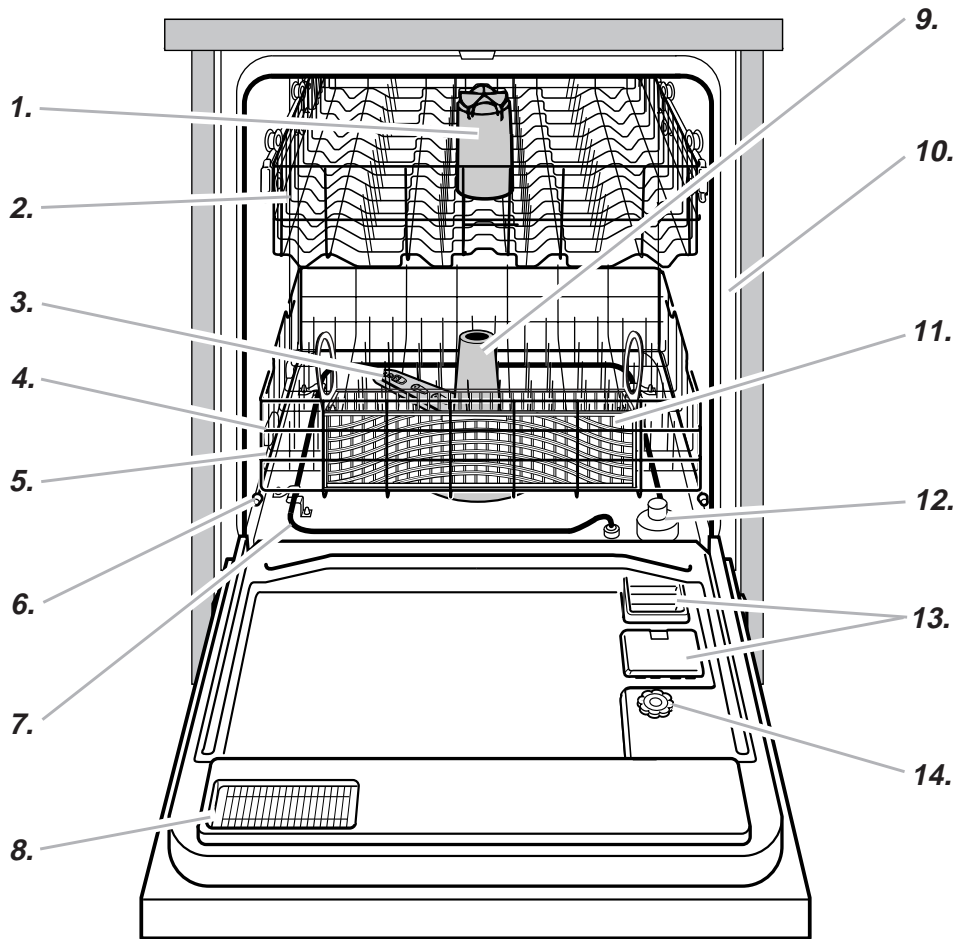

- |                        |                                   |
|------------------------|-----------------------------------|
| 1. Third level wash    | 8. Vent                           |
| 2. Top rack            | 9. Spray tower and protector      |
| 3. Lower spray arm     | 10. Model and serial number label |
| 4. Water inlet opening | 11. Silverware basket             |
| 5. Bottom rack         | 12. Overfill protection float     |
| 6. Rack bumper         | 13. Detergent dispensers          |
| 7. Heating element     | 14. Rinse aid dispenser           |

## Control Panel



---

# START-UP GUIDE

Before using your dishwasher, remove all hang tags, temporary labels, and packaging materials. Read this entire Use and Care Guide. You will find important safety information and useful operating tips.

---

## Using Your New Dishwasher

1. Scrape large food soil and hard items (toothpicks or bones) from dishes.
2. Properly load the dishwasher. (See "Loading Your Dishwasher.") Make sure nothing prevents the spray arm(s) from spinning freely.

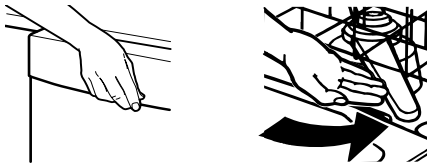

3. Add detergent and check the rinse aid dispenser. Add rinse aid if needed. (See "Using Your Dishwasher.")

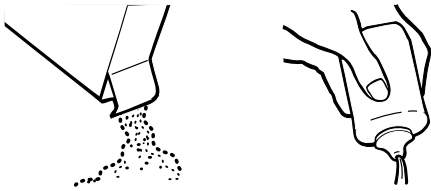

4. Push door firmly closed. The door latches automatically. Run hot water at the sink nearest your dishwasher until the water is hot. (See "Dishwasher Efficiency Tips.") Turn off water.

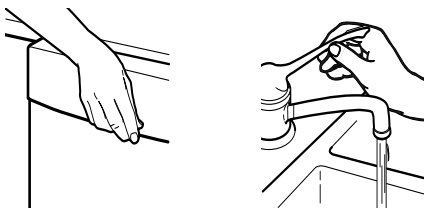

5. Select the desired cycle. (See "Using Your Dishwasher.")

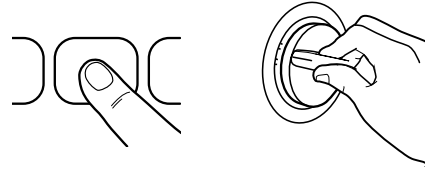

6. Select the desired option. (See "Option Selections.")

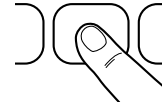

---

## Stopping Your Dishwasher

You can stop your dishwasher anytime during a cycle.

1. Open the door slightly.
2. Wait for the spraying action to stop. Then open the door all the way, if needed.

Close the door to continue the cycle.

### OR

1. Turn the Cycle Control knob slowly clockwise until you hear water draining. Let the dishwasher drain completely.
2. Open the door.
3. Turn the Cycle Control knob to OFF.

# LOADING YOUR DISHWASHER

## Loading Suggestions

- Remove leftover food, bones, toothpicks and other hard items from the dishes. It is not necessary to rinse the dishes before putting them in the dishwasher.

**NOTE:** If hard items such as fruit seeds, nuts, and egg shells enter the wash system, you might hear chopping, grinding, crunching, or buzzing sounds. These sounds are normal. Do not let metallic items (such as pot handle screws) get into the wash system. Damage can occur.

- Load dishes so soiled surfaces face the spray (down or inward). It is important for the water spray to reach all soiled surfaces.
- Load dishes so they are not stacked or overlapping if possible. For best drying, water must be able to drain from all surfaces.
- Make sure pot lids and handles, pizza pans, cookie sheets, etc., do not interfere with the spray arm rotation.
- Run a rinse cycle to keep dishes moist if you do not plan to wash them soon. Foods like eggs, rice, pasta, spinach, and cooked cereals may be hard to remove if they are left to dry over a period of time.

### Quiet operating tips

To avoid thumping/clattering noises during operation:

- Make sure lightweight load items are secured in the racks.
- Make sure pot lids and handles, pizza pans, cookie sheets, etc., do not touch interior walls or interfere with the rotation of the spray arm.
- Load dishes so they do not touch one another.

**NOTE:** For built-in models, keep sink drain plugs closed during dishwasher operation to prevent noise transfer through drains.

## Loading the Top Rack

The top rack is designed for cups, glasses, and smaller items. (See recommended loading patterns shown.)

**NOTE:** The features on your dishwasher rack may vary from the drawings shown.

Do not cover third level spray (on some models). See arrow.

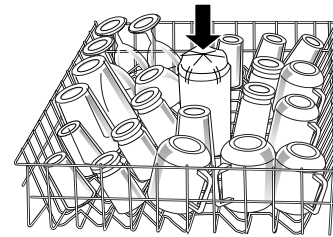

*Cup and glass load*

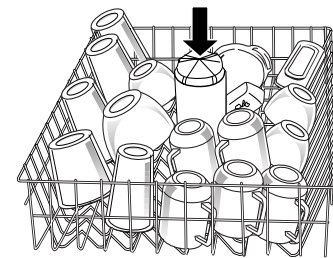

*Mixed load*

- Place items so open ends face down for cleaning and draining.
- Load glasses and cups in top rack only. The bottom rack is not designed for glasses and cups. Damage can occur.
- Place cups and glasses in the rows between prongs. Placing them over the prongs can lead to breakage.
- To avoid chipping, do not let stemware touch other items.
- China, crystal, and other delicate items must not touch each other during dishwasher operation. Damage can occur.
- Wedge lightweight items against one another or overlap them with heavier dishes.
- Load plastic items securely in the top rack only. Wash only plastic items marked "dishwasher safe."
- Small bowls, pans, and other utensils can be placed in the top rack.
- Load bowls in the center section for best stability.

## Loading the Bottom Rack

The bottom rack is designed for plates, pans, casseroles, and utensils. Items with cooked-on or dried-on food should be loaded with soiled surfaces facing inward to the spray. (See recommended loading patterns shown.)

**NOTE:** The features on your dishwasher rack may vary from the drawings shown.

Do not cover spray tower. See arrow.

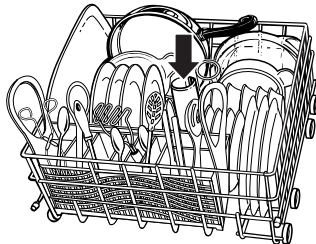

*Mixed load*

- Do not load glasses, cups, or plastic items in the bottom rack. Load small items in the bottom rack only if they are secured in place.
- Load plates, soup bowls, etc., between prongs and facing inward to the spray.
- Overlap the edges of plates for large loads.
- Load soup, cereal, and serving bowls in the rack in a variety of ways depending upon their size and shape. Load bowls securely between the rows of prongs. Do not nest bowls because the spray will not reach all surfaces.

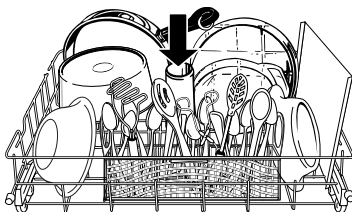

*Utensil load*

- Secure heavily soiled cookware face down in the rack.
- Make sure pot handles and other items do not stop rotation of the spray arm(s). The spray arm(s) must move freely.
- Do not load items between the bottom rack and the side of the dishwasher tub. You can block the water inlet opening.

**NOTE:** If you have removed the bottom rack for unloading or cleaning, replace it with the bumpers in front.

## Loading the Silverware Basket

Load the silverware basket while it is in the bottom rack or take the basket out for loading on a counter or table.

**NOTE:** You can remove the basket for easy unloading. Unload or remove the basket before unloading the racks to avoid spilling water droplets on the silverware.

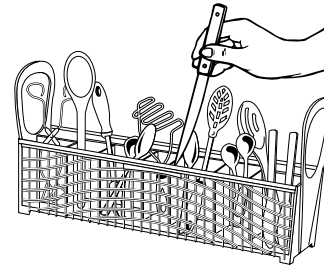

Mix items in each section of the basket with some pointing up and some down to avoid nesting. Spray cannot reach nested items.

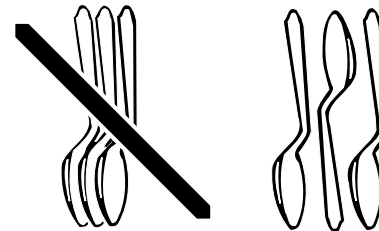

**IMPORTANT:** Always load sharp items (knives, skewers, forks, etc.) pointing down.

### NOTES:

- Do not load silver or silver-plated silverware with stainless steel. These metals can be damaged by contact with each other during washing.
- Some foods (such as salt, vinegar, milk products, fruit juices, etc.) can pit or corrode silverware. Run a rinse cycle if you do not have a full load to wash immediately.

# USING YOUR DISHWASHER

## Detergent Dispenser

The detergent dispenser has 2 sections. The Pre-Wash section empties detergent into the dishwasher when you close the door. The Main Wash section automatically empties detergent into the dishwasher during the wash cycle.

- Use automatic dishwashing detergent only. Other detergents can produce excessive suds that can overflow out of the dishwasher and reduce washing performance.
- Add detergent just before starting cycle.
- Store tightly closed detergent in a cool, dry place. Fresh automatic dishwasher detergent results in better cleaning.

**NOTE:** Do not use detergent with a rinse cycle.

### Filling the dispenser

1. If the dispenser cover is closed, open the cover by pushing the Cover Latch.

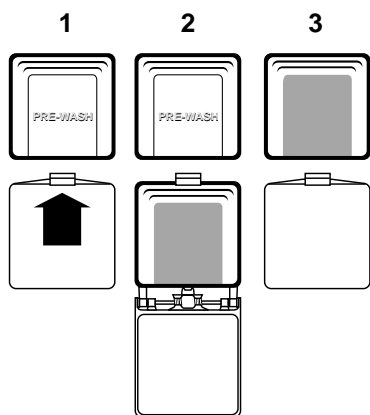

2. Fill the Main Wash section with detergent. See "How Much Detergent to Use."
3. Close the Main Wash dispenser cover. Fill the Pre-Wash section if needed.

It is normal for the cover to open partially when dispensing detergent.

**NOTE:** Use both sections for cycles with 2 washes. Use only the covered section for cycles with 1 wash. See the "Cycle Selection Chart" for more details.

## How Much Detergent to Use

- The amount of detergent to use depends on the hardness of your water and the type of detergent. If you use too little, dishes won't be clean. If you use too much in soft water, glassware will etch.
- Water hardness can change over a period of time. Find out your water's hardness by asking your local water department, water softener company, or county extension agent.
- Different brands of dishwasher detergent have different amounts of phosphorous for softening water. If you have hard water and use a detergent with a phosphorous content of less than 8.7%, you might need to use more detergent, or use a detergent with a phosphorous content higher than 8.7%.

### Where to fill



Completely full (3 tbs or 45 g)



Top of 2nd step (2 tbs or 30 g)



Top of 1st step (1 tb or 15 g)

Water Hardness	Amount of Detergent
<b>Soft to Medium Hard Water</b> 0 to 4 grains per gallon	■ Partially fill the Main Wash section (1 tb or 15 g)
	■ Fill the Pre-Wash section (1 tb or 15 g)
<b>Medium to Hard Water</b> 5 to 7 grains per gallon	■ Fill the Main Wash section (2 tbs or 30 g)
	■ Fill the Pre-Wash section (2 tbs or 30 g)
<b>Very Hard Water</b> 8 grains per gallon and above	■ Fill the Main Wash section (3 tbs or 45 g)
	■ Fill the Pre-Wash section (3 tbs or 45 g)

**NOTE:** Fill amounts shown are for standard powdered detergent. Amounts may vary if you use liquid or concentrated powdered detergent. Follow instructions on the package when using liquid dishwasher detergent or concentrated powdered detergent.

---

## Rinse Aid Dispenser

A rinse aid prevents water from forming droplets that can dry as spots or streaks. It also improves drying by allowing water to drain off of the dishes during the final rinse by releasing a small amount of the rinse aid into the rinse water. Your dishwasher is designed to use a liquid rinse aid. Do not use a solid or bar-type rinse aid.

### Checking the dispenser

Check the center of the Fill Indicator Cap. Clear means it needs filling.

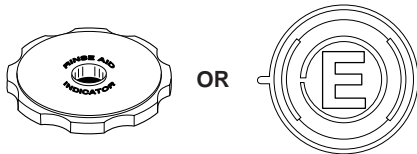

Or you can remove the Fill Indicator Cap. If an “E” is visible, the dispenser is empty.

### Filling the dispenser

The rinse aid dispenser holds 6 oz (175 mL) of rinse aid. Under normal conditions, this will last for about three months. You do not have to wait until the dispenser is empty to refill it. Try to keep it full, but be careful not to overfill it.

1. Make sure the dishwasher door is completely open.
2. Remove the Fill Indicator cap.
3. Add rinse aid. Fill to the smallest opening in the lower part of the dispenser. Overfilling can cause the rinse aid to leak out, and could cause oversudsing.

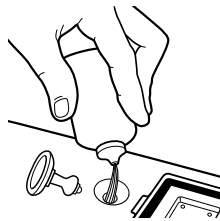

4. Clean up any spilled rinse aid with a damp cloth.
5. Replace the Fill Indicator Cap. Close tightly.

---

## Dishwasher Efficiency Tips

Hot water dissolves and activates the dishwashing detergent. Hot water also dissolves grease on dishes and helps glasses dry spot-free. For best dishwashing results, water must be at least 120°F (49°C) as it enters the dishwasher. Loads may not wash as well if the water temperature is too low.

### To check water temperature

1. Run hot water at the faucet closest to your dishwasher for at least 1 minute.
2. Measure the water temperature with a candy or meat thermometer placed in the running stream of water.

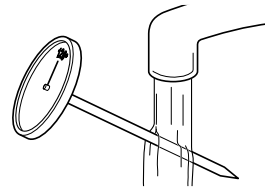

3. If the water temperature at the faucet is below 120°F (49°C), have a qualified person raise the water heater's thermostat setting.
  - To save water and energy, do not rinse dishes before putting them into the dishwasher.
  - Use a low energy, quick, or short cycle whenever possible. These cycles use less hot water and energy than the Normal wash cycle.
  - Use a delay feature (on some models) to run your dishwasher during off-peak hours. Local utilities recommend avoiding heavy usage of energy at certain times of day.
  - During the summer, run your dishwasher at night to reduce daytime heat buildup.
  - Use an air dry, or an energy saving dry option whenever possible. Allow longer drying times (overnight) when using these options. Use a rinse aid to improve drying.
  - Use cycles or options that add extra heat to the wash or rinse portion of the cycle only when needed.
  - Run your dishwasher with full loads. Run a rinse cycle after meals until the dishwasher is full.

## Cycle Selection Chart

Select the wash cycle. If the door is latched, you will hear the cycles start and stop as the Cycle Control knob passes each cycle mark. This is normal and does not hurt the dishwasher. If you prefer, you can set the Cycle Control knob with the door unlatched.

**Press the desired cycle. Turn the Cycle Control knob to the desired cycle.** To use Rinse Only, press any cycle and turn the Cycle Control knob to Rinse Only.

**NOTE:** Use the Air Dry option with the Rinse & Hold cycle.

A "●" shows what steps are in each cycle.

<b>POTS -N- PANS</b>	Use this cycle for hard-to-clean, heavily soiled pots, pans, casseroles, regular tableware.							
	Use both detergent dispenser sections.							
Pre-Wash	Rinse	Rinse	Main Wash	Rinse	Final Rinse	Dry	Time (min)	Water Usage (gal/L)
●	●	●	●	●	●	●	98	8.6/32.6

<b>NORMAL</b>	Use this cycle for loads with normal amounts of food soil. (The energy usage label is based on this cycle.)							
	Use both detergent dispenser sections.							
Pre-Wash	Rinse	Rinse	Main Wash	Rinse	Final Rinse	Dry	Time (min)	Water Usage (gal/L)
●		●	●	●	●	●	90	7.2/27.3

<b>LIGHT</b>	Use this cycle for pre-rinsed or lightly soiled loads.							
	Use covered detergent dispenser section.							
Pre-Wash	Rinse	Rinse	Main Wash	Rinse	Final Rinse	Dry	Time (min)	Water Usage (gal/L)
		●	●	●	●	●	85	5.7/21.6

<b>RINSE ONLY</b>	Use this rinse cycle for rinsing dishes, glasses, and silverware that will be washed later. Use air dry.							
	Do not use detergent with the rinse cycle.							
Pre-Wash	Rinse	Rinse	Main Wash	Rinse	Final Rinse	Dry	Time (min)	Water Usage (gal/L)
				●	●		20	2.9/11.0

## Canceling a Cycle

You can cancel a cycle at any time.

1. Turn the Cycle Control knob slowly clockwise until you hear water draining. Let the dishwasher drain completely.
2. Open the door.
3. Turn the Cycle Control knob to OFF.

## Changing a Cycle or Setting

If your dishwasher has more than one wash cycle, you can change a cycle anytime during a cycle.

1. Lift the door latch to stop the cycle.
2. Turn the Cycle Control knob clockwise.
3. Check the detergent dispensers. They must be filled properly for the new cycle.

**NOTE:** Turning the Cycle Control knob can cause the covered Detergent Dispenser section to open and release the detergent. Check the covered section if the cycle uses detergent in both sections.

4. Close the door firmly until it latches. The dishwasher starts a new cycle.

## Adding Items During a Cycle

You can add an item anytime before the main wash starts, or the Cycle Control knob reaches Light Wash (on some models).

1. Lift up the door latch to stop the cycle. Wait for the spraying action to stop before opening the door.
2. Open the door and add the item.
3. Close the door, but do not latch it. Wait 30 seconds for the air in the dishwasher to warm up. This reduces the amount of moisture escaping from the vent when restarting a cycle.
4. Close the door firmly until it latches. The dishwasher resumes the cycle.

---

## Option Selections

Select either Air Dry or Heat Dry for each wash cycle. You can change an option anytime before the selected option begins. For example, you can press an unheated drying option any time before drying begins.

### Air Dry

Select this option to dry dishes without heat and save energy. The dishes take longer to dry and some spotting can occur.



For best drying, use a liquid rinse aid. Some items (such as plastics) may need towel drying.

### Heat Dry

Select this option to dry dishes with heated air. For best drying results, use a liquid rinse aid and heated drying.



**NOTE:** Heat Dry is an option for all cycles except Rinse Only.

### Delay Hours

Select this option to run your dishwasher at a later time or during off-peak hours.

#### To delay the start

1. Close the door.
2. Select a wash cycle and option.  
Press the desired cycle. Turn the Cycle Control knob clockwise to the number of hours you want the dishwasher to delay the start.

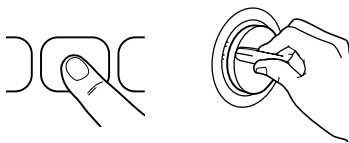

The dishwasher starts the cycle in the selected number of hours. You can add items while the time is counting down.

3. Close and latch the door. The Cycle Control knob will not advance if the door is unlatched.

#### NOTES:

- To cancel the delay, turn the Cycle Control knob to the desired cycle.
- Rinse Only and the Light wash cycles cannot be delayed.

#### IMPORTANT:

- Operate your dishwasher only when you are at home.
- If your home is equipped with a water softener, do not start the dishwasher during the regeneration of the softener.

---

## Drying System

During drying, you can see steam escaping through the vent at the upper left corner of the door. This is normal as the heat dries your dishes.

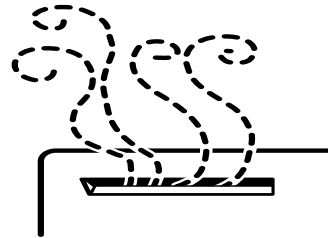

**IMPORTANT:** The vapor is hot. Do not touch the vent during drying.

---

## Overfill Protection Float

The overfill protector (in the front right corner of the dishwasher tub) keeps the dishwasher from overfilling. It must be in place for the dishwasher to operate.

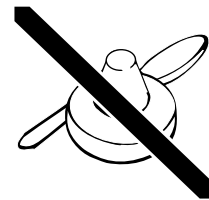

Check under the float for objects that may keep the protector from moving up or down.

# WASHING SPECIAL ITEMS

If you have doubts about washing a particular item, check with the manufacturer to see if it is dishwasher safe.

MATERIAL	DISHWASHER SAFE?/ COMMENTS
Aluminum	<b>Yes</b> High water temperature and detergents can affect finish of anodized aluminum.
Disposable Aluminum	<b>No</b> Do not wash throwaway aluminum pans in the dishwasher. These might shift during washing and transfer black marks to dishes and other items.
Bottles and Cans	<b>No</b> Wash bottles and cans by hand. Labels attached with glue can loosen and clog the spray arms or pump and reduce washing performance.
Cast Iron	<b>No</b> Seasoning will be removed and iron will rust.
China/ Stoneware	<b>Yes</b> Always check manufacturer's recommendations before washing. Antique, hand-painted, or over-the-glaze patterns may fade. Gold leaf can discolor or fade.
Crystal	<b>Yes</b> Check manufacturer's recommendations before washing. Some types of leaded crystal can etch with repeated washing.
Gold	<b>No</b> Gold-colored flatware will discolor.
Glass	<b>Yes</b> Milk glass yellows with repeated dishwasher washing.
Hollow-Handle Knives	<b>No</b> Handles of some knives are attached to the blade with adhesives which can loosen if washed in the dishwasher.

MATERIAL	DISHWASHER SAFE?/ COMMENTS
Pewter, Brass, Bronze	<b>No</b> High water temperatures and detergent can discolor or pit the finish.
Disposable Plastics	<b>No</b> Cannot withstand high water temperatures and detergents.
Plastics	<b>Yes</b> Always check manufacturer's recommendations before washing. Plastics vary in their capacity to withstand high water temperatures and detergents. Load plastics in top rack only.
Stainless Steel	<b>Yes</b> Run a rinse cycle if not washing immediately. Prolonged contact with food containing salt, vinegar, milk products, or fruit juice can damage finish.
Sterling Silver or Silver Plate	<b>Yes</b> Run a rinse cycle if not washing immediately. Prolonged contact with food containing salt, acid, or sulfide (eggs, mayonnaise, and seafood) can damage finish.
Tin	<b>No</b> Can rust.
Wooden Ware	<b>No</b> Wash by hand. Always check manufacturer's instructions before washing. Untreated wood can warp, crack, or lose its finish.

---

# CARING FOR YOUR DISHWASHER

---

## Cleaning Your Dishwasher

### Cleaning the exterior

In most cases, regular use of a soft, damp cloth or sponge and a mild detergent is all that is necessary to keep the outside of your dishwasher looking nice and clean.

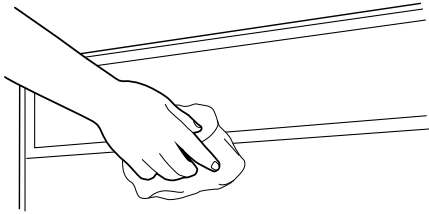

### Cleaning the interior

Hard water minerals can cause a white film to build up on the inside surfaces, especially just beneath the door area.

**Do not** clean the dishwasher interior until it has cooled. Wear rubber gloves. **Do not** use any type of cleanser other than dishwasher detergent because it may cause foaming or sudsing.

#### To clean interior

Make a paste with powdered dishwasher detergent on a damp sponge and clean.

**OR**

Use liquid automatic dishwasher detergent and clean with a damp sponge.

**OR**

See the vinegar rinse procedure in "Spotting and filming on dishes" in "Troubleshooting."

**NOTE:** Run a normal wash cycle with detergent after cleaning the interior.

---

## Cleaning the Filter Screen

The filter system requires periodic cleaning as needed.

### To clean screen

1. Unload the bottom rack. Slide the rack forward or remove the rack to reach the filter screen.
2. Remove collected particles from the screen with your fingers or a paper towel.

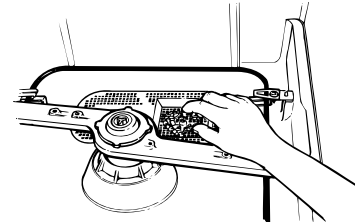

3. Replace the bottom rack with the rack bumpers facing the door.

**NOTE:** Do not clean the dishwasher interior until it has cooled.

---

## Drain Air Gap

### Check the drain air gap anytime your dishwasher isn't draining well

Some state or local plumbing codes require the addition of a drain air gap between a built-in dishwasher and the home drain system. If a drain is clogged, the drain air gap protects your dishwasher from water backing up into it.

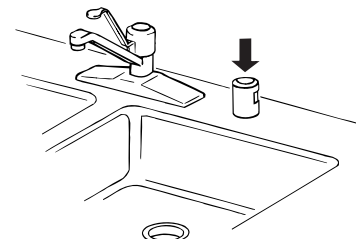

The drain air gap is usually located on top of the sink or countertop near the dishwasher. To order a drain air gap contact your local dealer, or in the U.S.A., call the Consumer Assistance Center at 1-800-253-1301 and ask for Part Number 300096.

**NOTE:** The drain air gap is an external plumbing device that is not part of your dishwasher. The warranty provided with your dishwasher does not cover service costs directly associated with the cleaning or repair of the external drain air gap.

### To clean the drain air gap

Clean the drain air gap periodically to ensure proper drainage of your dishwasher. Follow the cleaning instructions provided by the manufacturer. With most types, you lift off the chrome cover. Unscrew the plastic cap. Then check for any soil buildup. Clean if necessary.

---

# Storing Your Dishwasher

## Storing for the summer

Protect your dishwasher during the summer months by turning off the water supply and power supply to the dishwasher.

## Moving or winterizing your dishwasher

Protect your dishwasher and home against water damage due to freezing water lines. If your dishwasher is left in a seasonal dwelling or could be exposed to near freezing temperatures, have a qualified person do the following:

1. Disconnect power supply to the dishwasher.
2. Turn off water supply to the dishwasher.
3. Remove the 4 screws on the lower access panel. Remove the lower access panel.

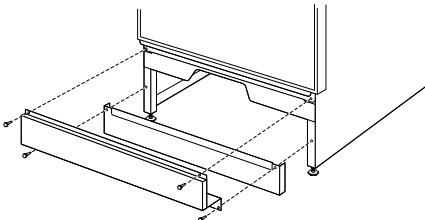

4. Place a shallow pan under the water supply valve. Then, use a wrench to disconnect the water inlet from the water supply valve. Separate the water inlet from the water supply valve and drain water into the pan.

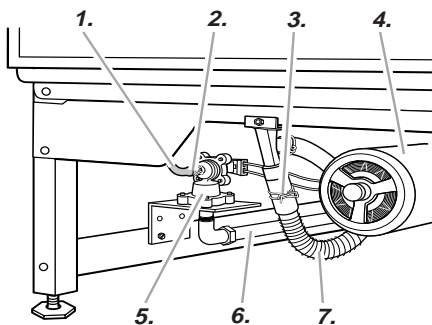

1. Water outlet
2. Spring clamp
3. Screw clamp
4. Water pump and motor
5. Water supply valve
6. Water inlet
7. Drain hose

5. Remove the spring clamp from the water outlet and separate from the water supply valve; drain water into pan.
6. Reconnect both water inlet and water outlet to the water supply valve.
7. Empty the pan and reposition it under the water pump.
8. Remove the clamp and disconnect the drain hose from the water pump; drain water into pan.
9. Reconnect drain hose to the water pump, being sure to position the clamp over the connection.
10. Replace the lower access panel.

**NOTE:** If your dishwasher is connected to a garbage disposal, do not run water into the sink after winterizing. This could cause water to refill the drain hose on your dishwasher.

## Reconnecting your dishwasher

1. Remove the 4 screws on the lower access panel and remove lower access panel.
2. Turn on the water supply to dishwasher.
3. Turn on power supply to dishwasher.
4. Run dishwasher through a complete cycle and check for leaks.
5. Replace lower access panel.

---

# TROUBLESHOOTING

First try the solutions suggested here and possibly avoid the cost of a service call...

---

## Dishwasher is not operating properly

---

- **Dishwasher does not run or stops during a cycle**

Is the door closed tightly and latched?

Is the right cycle selected? Refer to the “Cycle Selection Chart.”

Is there power to the dishwasher? Has a household fuse blown or circuit breaker tripped?

Has the motor stopped due to an overload? The motor automatically resets itself within a few minutes. If it does not restart, call for service.

Is the water shut-off valve (if installed) turned on?
- **Dishwasher will not fill**

Is the overflow protection float able to move up and down freely? Press down to release.
- **Water remains in the dishwasher**

Is the cycle complete?
- **Detergent remains in the covered section of the dispenser**

Is the cycle complete?

Is the detergent lump-free? Replace detergent if necessary.

Is the bottom rack installed properly with the bumpers in the front? Refer to the “Parts and Features” section. Reinstall the rack if necessary.
- **White residue on the front of the access panel**

Was too much detergent used? Refer to the “Detergent Dispenser” section.

Is the brand of detergent making excess foam? Try a different brand to reduce foaming and eliminate buildup.
- **Odor in the dishwasher**

Are dishes washed only every 2 or 3 days? Run a rinse cycle once or twice a day until you have a full load.

Does the dishwasher have a new plastic smell? Run a vinegar rinse as described in “Spotting and filming on dishes” later in this Troubleshooting guide.
- **Condensation on the kitchen counter (built-in models)**

Is the dishwasher aligned with the counter top? Moisture from the vent in the dishwasher console can form on the counter. Refer to the Installation Instructions for more information.

---

## Dishes are not completely clean

---

- **Food soil left on the dishes**

Is the dishwasher loaded correctly? Refer to the “Loading Your Dishwasher” section.

Is the water temperature too low? If needed, turn home water heater up to ensure water entering dishwasher is at least 120°F (49°C). Refer to the “Dishwasher Efficiency Tips” section.

Did you use the correct amount of fresh detergent? Use recommended dishwasher detergents only. Refer to the “Detergent Dispenser” section. Never use less than one tablespoon (15 g) per load. Detergent must be fresh to be effective. Store detergent in a cool, dry area. Heavy soil and/or hard water generally require extra detergent.

Is detergent caked in dispenser? Use fresh detergent only. Do not allow detergent to sit for several hours in a wet dispenser. Clean dispenser when caked detergent is present.

Is the pump or spray arm clogged by labels from bottles and cans? Remove labels before washing bottles and cans or wash by hand.

Is the home water pressure high enough for proper dishwasher filling? Home water pressure should be 20 to 120 psi (138 to 828 kPa) for proper dishwasher fill. A booster pump on the water supply can be added if pressure is too low.

Are high suds slowing the wash arm? Never use soap or laundry detergents. Use recommended dishwasher detergents only.
- **Dishwasher door will not close**

Is the bottom rack in backwards? The rack bumpers must face the dishwasher door.

---

## Spots and stains on dishes

---

- **Spotting and filming on dishes**

Is your water hard or is there a high mineral content in your water? Conditioning the final rinse water with a liquid rinse aid helps eliminate spotting and filming. Keep the rinse aid dispenser filled.

Is the water temperature too low? If needed, turn home water heater up to ensure water entering dishwasher is at least 120°F (49°C). Refer to the “Dishwasher Efficiency Tips” section.

Did you use the correct amount of effective detergent? Use recommended dishwasher detergents only. Refer to the “Detergent Dispenser” section. Never use less than 1 tablespoon (15 g) per load. Detergent must be fresh to be effective. Store detergent in a cool, dry area. Heavy soil and/or hard water generally require extra detergent.

Is the home water pressure high enough for proper dishwasher filling? Home water pressure should be 20 to 120 psi (138 to 828 kPa) for proper dishwasher fill. A booster pump on the water supply can be added if pressure is too low.

**NOTE:** To remove spots and film from dishes, try a white vinegar rinse. This procedure is intended for occasional use only. Vinegar is an acid and using it too often could damage your dishwasher.

1. Wash and rinse dishes. Use an air-dry or an energy saving dry option. Remove all silverware or metal items.
2. Put 2 cups (473 mL) white vinegar in a glass or dishwasher-safe measuring cup on the bottom rack.
3. Run the dishwasher through a complete washing cycle using an air-dry or an energy saving dry option. Do not use detergent. Vinegar will mix with the wash water.

■ **Silica film or etching (silica film is a milky, rainbow-colored deposit; etching is a cloudy film)**

Sometimes there is a water/chemical reaction with certain types of glassware. This is usually caused by some combination of soft or softened water, alkaline washing solutions, insufficient rinsing, overloading the dishwasher, and the heat of drying. It might not be possible to prevent the problem, except by hand washing.

To slow this process use a minimum amount of detergent but not less than 1 tablespoon (15 g) per load. Use a liquid rinse aid and underload the dishwasher to allow thorough rinsing. Silica film and etching are permanent and cannot be removed. Do not use heated drying.

■ **White spots on cookware with non-stick finish**

Has the dishwasher detergent removed cookware seasoning? Reseason cookware after washing in the dishwasher.

■ **Brown stains on dishes and dishwasher interior**

Does your water have high iron content? Rewash dishes using 1-3 teaspoons (5-15 g) of citric acid crystals added to the covered section of the detergent dispenser. Do not use detergent. Follow with a Normal wash cycle with detergent. If treatment is needed more often than every other month, the installation of an iron removal unit is recommended.

■ **Black or gray marks on dishes**

Are aluminum items rubbing dishes during washing? Disposable aluminum items can break down in the dishwasher and cause marking. Hand wash these items. Remove aluminum markings by using a mild abrasive cleaner.

■ **Orange stains on plastic dishes or dishwasher interior**

Are large amounts of tomato-based foods on dishes placed in the dishwasher? Stains can gradually fade over time. Regular use of heated drying will slow fading. Stains will not affect dishwasher performance. Regular use of a rinse cycle and an air-dry or energy-saving dry option will reduce the likelihood of staining.

---

## Dishes do not dry completely

---

■ **Dishes are not dry**

Did you load your dishwasher to allow proper water drainage? Do not overload. Refer to the “Loading Your Dishwasher” section. Use a liquid rinse aid to speed drying.

Are the plastics wet? Plastics often need towel drying.

Is the rinse aid dispenser empty? Refer to the “Rinse Aid Dispenser” section.

Did you use an air-dry or energy-saving dry option? Use a heated drying option for dryer dishes.

---

## Dishes are damaged during a cycle

---

■ **Chipping of dishes**

Did you load the dishwasher properly? Load the dishes and glasses so they are stable and do not strike together from washing action. Minimize chipping by moving the rack in and out slowly.

**NOTE:** Antiques, feather-edged crystal, and similar types of china and glassware might be too delicate for automatic dishwashing. Wash by hand.

---

# ASSISTANCE OR SERVICE

Before calling for assistance or service, please check "Troubleshooting." It may save you the cost of a service call. If you still need help, follow the instructions below.

When calling, please know the purchase date and the complete model and serial number of your appliance. This information will help us to better respond to your request.

## **If you need replacement parts**

If you need to order replacement parts, we recommend that you only use Factory Specified Parts. Factory Specified Parts will fit right and work right, because they are made with the same precision used to build every new Kirkland Signature™ appliance by Whirlpool Corporation. To locate Factory Specified Parts in your area, call our Consumer Assistance Center telephone number or your nearest designated service center.

Call the Whirlpool Consumer Assistance Center toll free: **1-800-253-1301**.

## **Our consultants provide assistance with:**

- Features and specifications on our full line of appliances.
- Installation information.
- Use and maintenance procedures.
- Accessory and repair parts sales.
- Specialized customer assistance (Spanish speaking, hearing impaired, limited vision, etc.).
- Referrals to local dealers, repair parts distributors, and service companies. Whirlpool designated service technicians are trained to fulfill the product warranty and provide after-warranty service, anywhere in the United States.

To locate the Whirlpool designated service company in your area, you can also look in your telephone directory Yellow Pages.

## **For further assistance**

If you need further assistance, you can write to Whirlpool with any questions or concerns at:

Whirlpool Brand Home Appliances  
Consumer Assistance Center  
c/o Correspondence Dept.  
2000 North M-63  
Benton Harbor, MI 49022-2692

Please include a daytime phone number in your correspondence.

---

# NOTES

---

# DISHWASHER WARRANTY



By **Whirlpool**  
CORPORATION

---

## TWO-YEAR FULL WARRANTY

For two years from the date of installation, when this dishwasher is operated and maintained according to instructions attached to or furnished with the product, Whirlpool will pay for Factory Specified Parts and repair labor to correct defects in materials or workmanship. Service must be provided by a Whirlpool designated service company.

---

## TWENTY YEAR FULL WARRANTY

For twenty years from the date of installation, Whirlpool will pay for Factory Specified Parts and repair labor for the tub or inner door if either develops a water leak resulting from defective materials or workmanship. Service must be provided by a Whirlpool designated service company.

---

### Whirlpool Corporation will not pay for:

1. Service calls to correct the installation of your dishwasher, to instruct you how to use your dishwasher, to replace house fuses or to correct house wiring or plumbing.
2. Repairs when your dishwasher is used in other than normal, single-family household use.
3. Damage resulting from accident, alteration, misuse, abuse, fire, floods, acts of God, improper installation, or installation not in accordance with local electrical and plumbing codes.
4. Any labor costs during the limited warranty.
5. Replacement parts or repair labor costs for units operated outside the United States.
6. Pickup and delivery. This product is designed to be repaired in the home.
7. Repairs to parts or systems resulting from unauthorized modifications made to the appliance.

---

**THIS KIRKLAND SIGNATURE™ APPLIANCE IS WARRANTED BY WHIRLPOOL CORPORATION IN THE UNITED STATES. WHIRLPOOL DOES NOT ASSUME ANY RESPONSIBILITY FOR INCIDENTAL OR CONSEQUENTIAL DAMAGES.**

Some states do not allow the exclusion or limitation of incidental or consequential damages, so this exclusion or limitation may not apply to you. This warranty gives you specific legal rights and you may also have other rights which may vary from state to state.

**Outside the United States, a different warranty may apply. For details, please contact Whirlpool Corporation.**

If you need service, first see "Troubleshooting." Additional help can be found by checking "Assistance or Service," or by calling our Consumer Assistance Center at **1-800-253-1301**, from anywhere in the U.S.A. or write: Whirlpool Corporation, Consumer Assistance Center, c/o Correspondence Dept., 2000 North M-63, Benton Harbor, MI 49022-2692.

1/99

---

**Keep this book and your sales slip together for future reference. You must provide proof of purchase or installation date for in-warranty service.**

Write down the following information about your dishwasher to better help you obtain assistance or service if you ever need it. You will need to know your complete model number and serial number. You can find this information on the model and serial number label/plate, located on your appliance as shown in "Parts and Features."

**Dealer name** \_\_\_\_\_

**Address** \_\_\_\_\_

**Phone number** \_\_\_\_\_

**Model number** \_\_\_\_\_

**Serial number** \_\_\_\_\_

**Purchase date** \_\_\_\_\_